

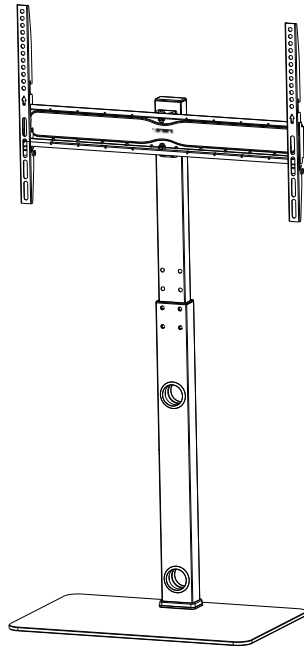

































TV Stand



Component Checklist

 1 (x1) TV Plate	 2 (x2) Monitor Brackets	 M4X15 TV1 X4	 M4X30 TV2 X4	 M6X15 TV3 X4	 M6X30 TV4 X4				
 3 (x1) Support Pillar	 4 (x1) Plastic Cover	 M8X15 TV4 X4	 M8X45 TV5 X4	 Washer TV6 X4	 SP1 TV7 X8				
 5 (x1) Tempered Glass	 6 (x1) Support Pillar	 SP2 TV8 X8							
 Safety Lock(x2) A	 M8x20x1 plastic washer(x5) B	 (x2) C	 wire clip(x2) D	 Rubber Foot(x6) E	 M8x50(x4) F	 M8x40 (x3) G	 M8x20 (x2) H		
 M6x40(x4) I	 M8(x6) J	 M6(x4) K	 M8x22x2(x3) L	 M8x16x1(x12) M	 M5x30(x2) N	 4mm(x1) O	 5mm(x1) O	 10mm(x1) P	 13mm(x1) P

1 3 + 4 + 5 + G(x3) + B(x3) + L(x3)
+ E(x6) + O(5mm)



Do not over-tighten part G.
Part L and B must be installed
in correct order shown on the diagram.

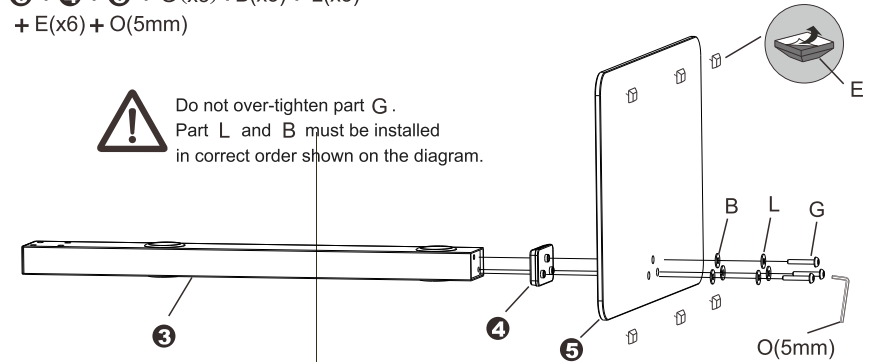

2 6 + F(x4) + M(x4) + J(x4) + O(5mm)
+ P(13mm)

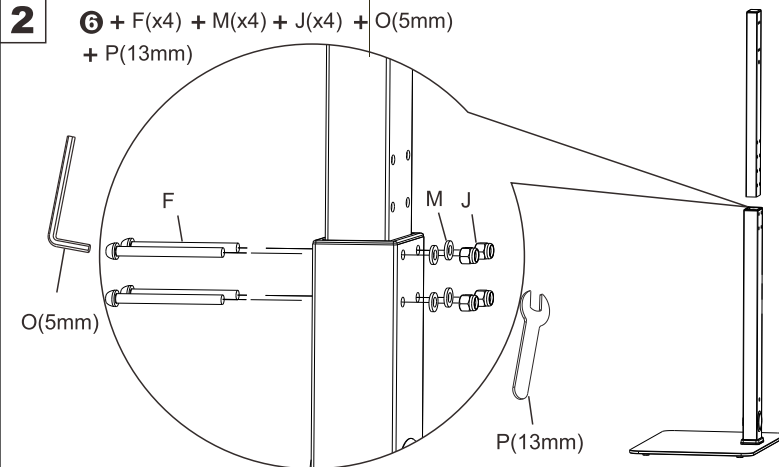

3 C(x2) + I(x4) + M(x4) + K(x4) + O(4mm)
+ P(10mm)

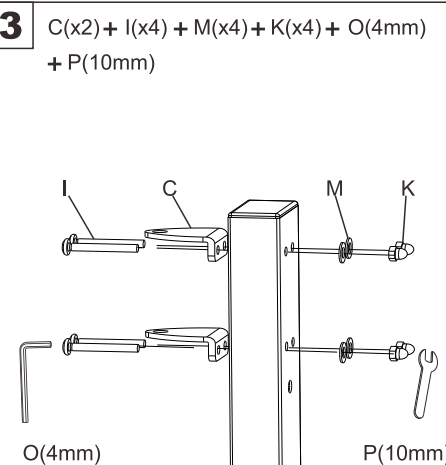

4 1 + B(x2)

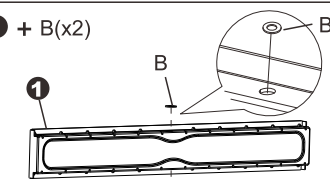

5 H(x2) + J(x2) + M(x4) + O(5mm) + P(13mm)

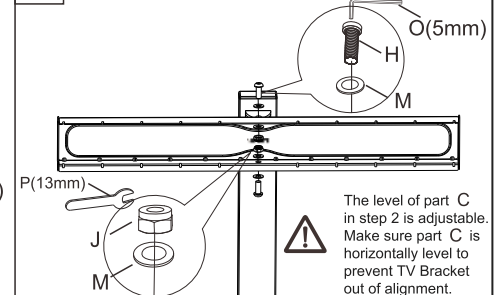

6 Check TV Screws

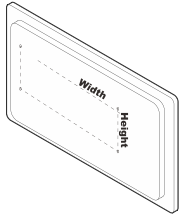

Measure the distance between the holes located at the back of your TV (these measures may form the shape of a square, or a rectangle) and check that these taken measures are within the VESA(*) range for this wall mount. (*) VESA: International standard established by the TV manufacturers used to determine if LCD / LED TVs are compatible with wall mounts.

75 mm ≈ 2 7/8 in 100 mm ≈ 4 in
200 mm ≈ 7 7/8 in 300 mm ≈ 11 3/4 in
400 mm ≈ 15 3/4 in

Check TV screws

Please select the proper screw length for your TV by hand tightening to check your flat panel thread depth.



When attaching brackets to the flat screen, be careful not to over tighten screws and be sure that screws do not bottom out in the mounting holes.

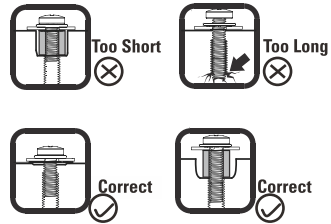

7 Mounting the Monitor Bracket to a TV

2		x 2
TV1		x 4
TV1		x 4
TV2		x 4
TV3		x 4
TV4		x 4
TV5		x 4
TV6		x 4
TV7		x 8
TV8		x 8

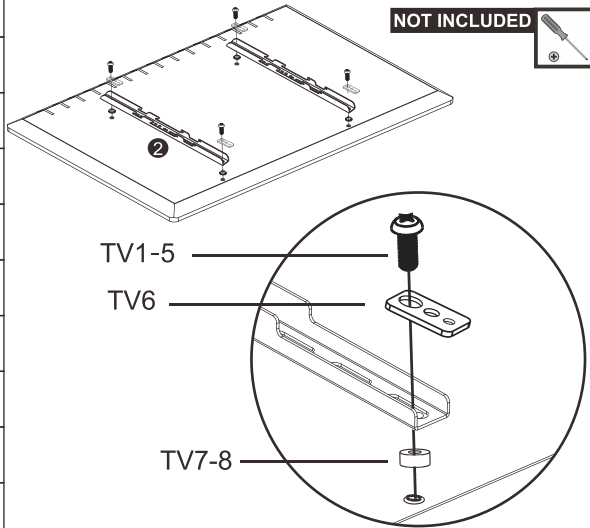

First, make sure the diameter of the bolt (TV1-5) fits your TV. Then, please see the diagram above. You will need to thread the bolt into the TV using the correct washer (TV6) and spacer (TV7-8) if necessary. Please make sure the monitor brackets are vertically centered and level with each other

8 Attaching TV to TV Plate

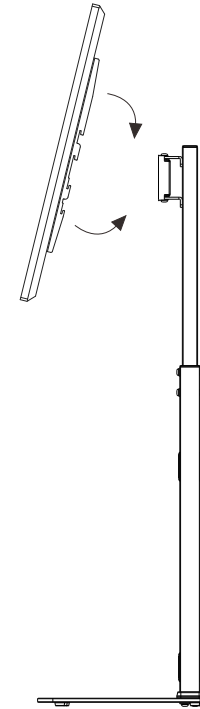

A(x2) + N(x2)

NOT INCLUDED

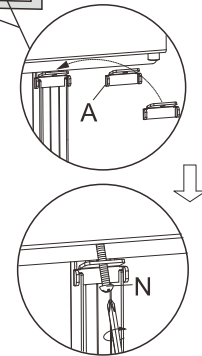
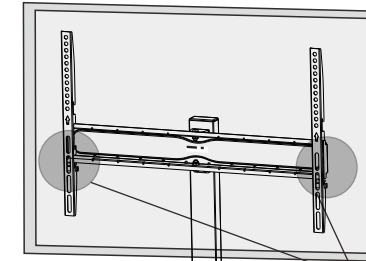

D x2

